

长沙中联环境产业公司 服务支持室



目录 CONTENTS



参				
	(T)	5.6	10.37	
1	()	6.2	12.8	20
2		0.8	2	
3	S	19	25	30
4	S	10	15	10
5	S	45	45	55

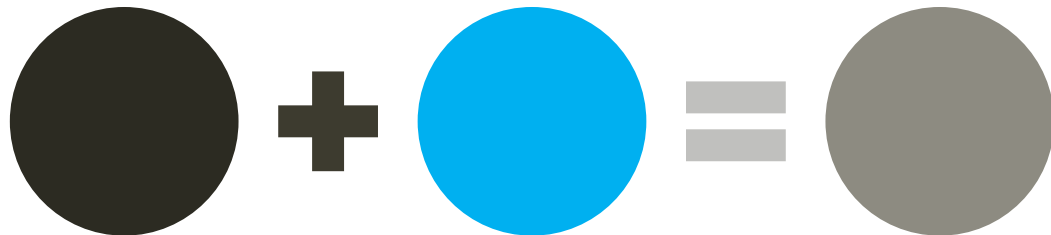

5080ZYS 8-5.6=2.4 T
5180ZYS 18-10.4=7.6(T)



1 3
0.9

5080ZYS

0.4 t/m³

5180ZYS

0.6 t/m³

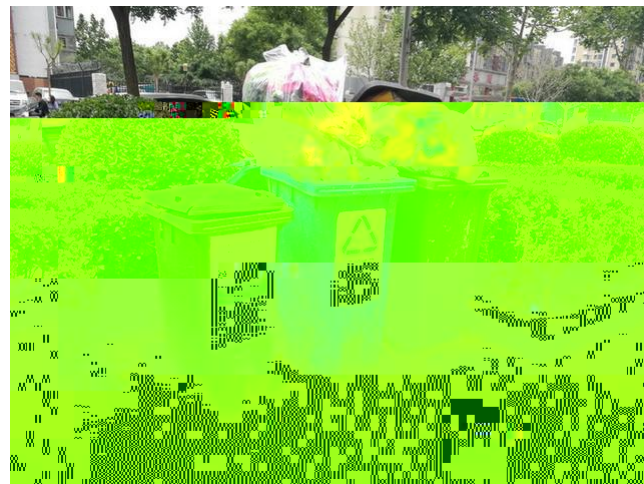

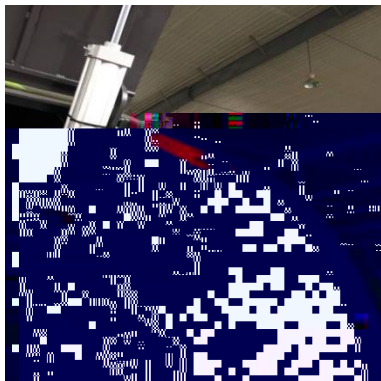
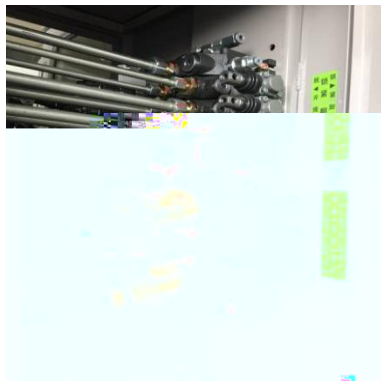
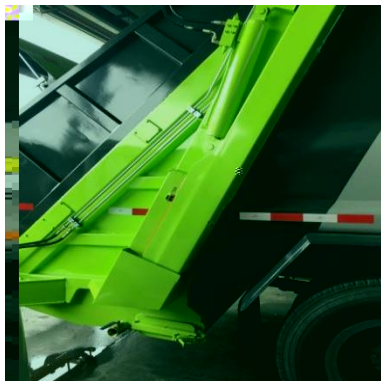

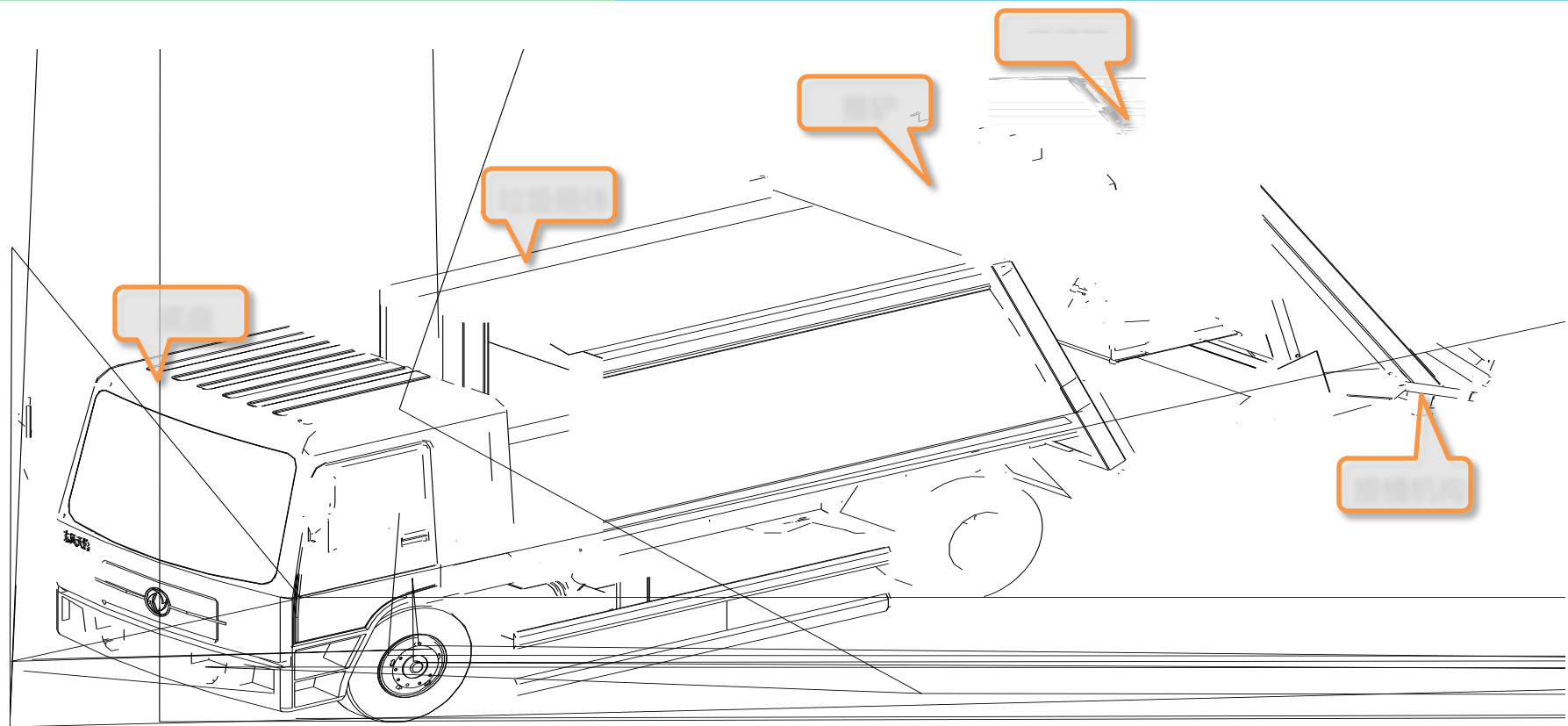

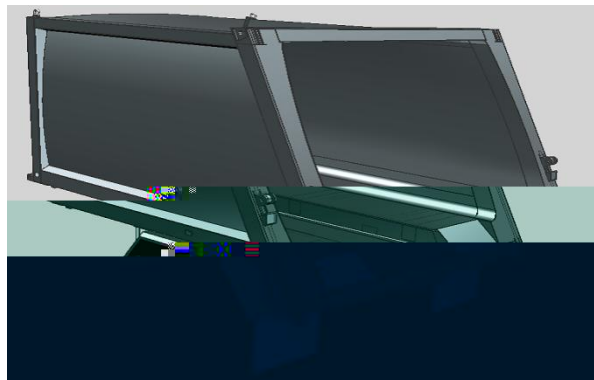
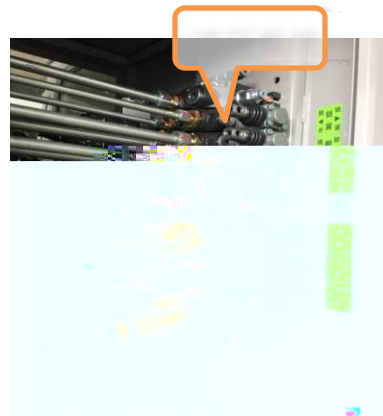
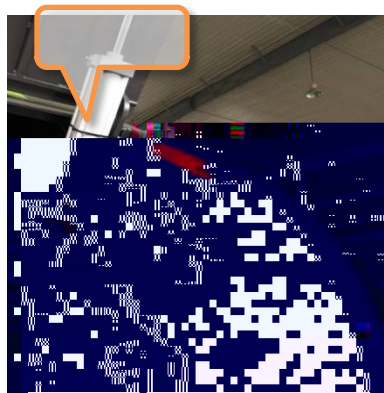



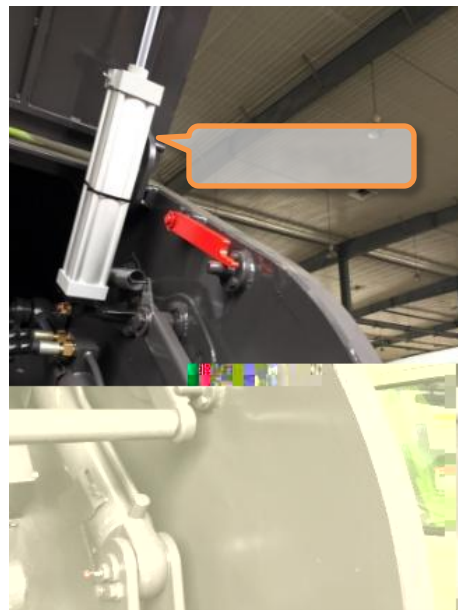

保

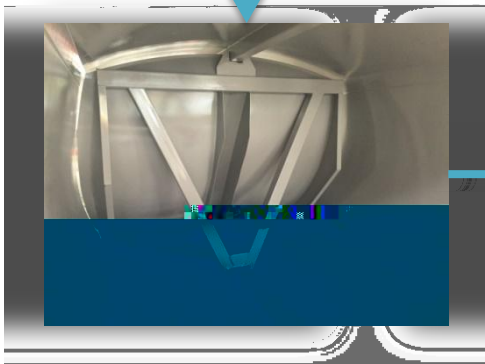

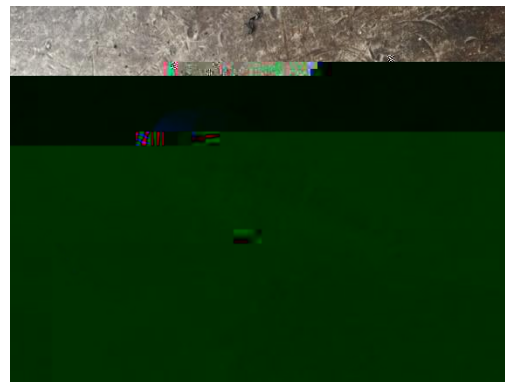

1
1
2
1
1
1

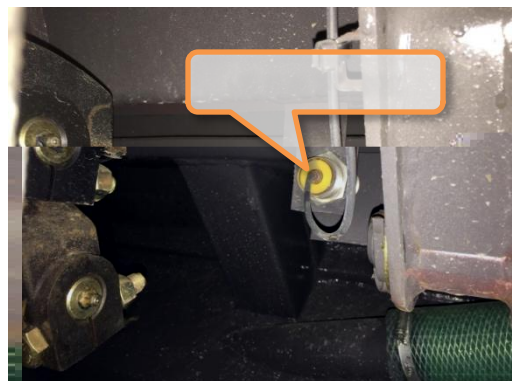
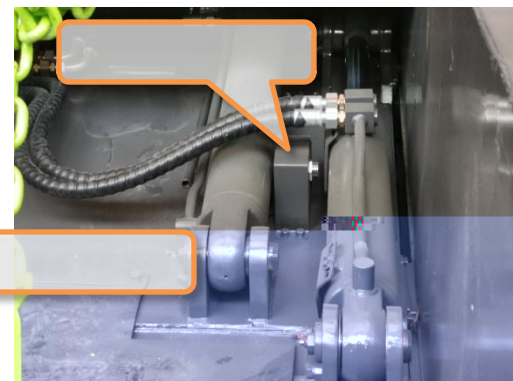



目录 CONTENTS





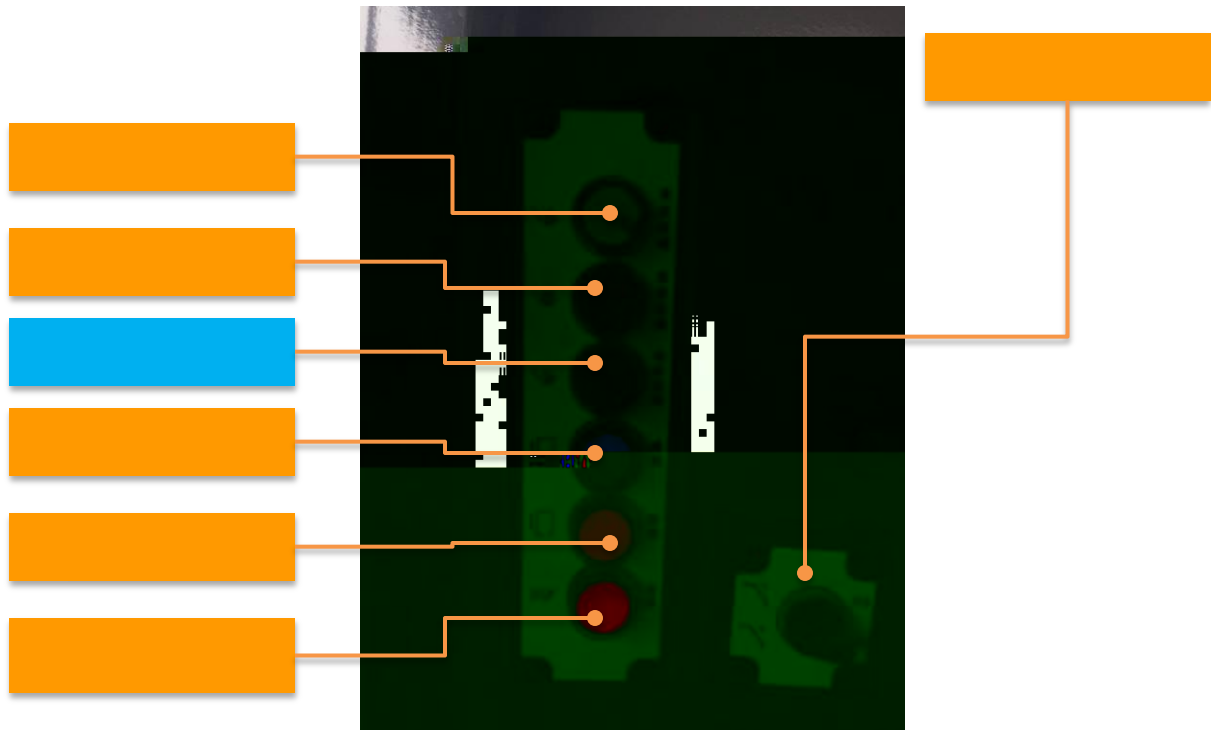





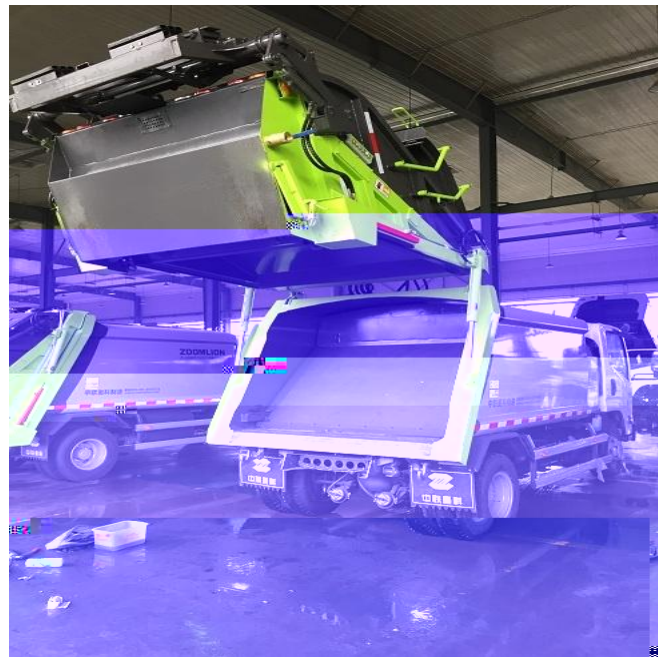



目录 CONTENTS



1		5	()
2		50	(
3		250	(
4		1000	(

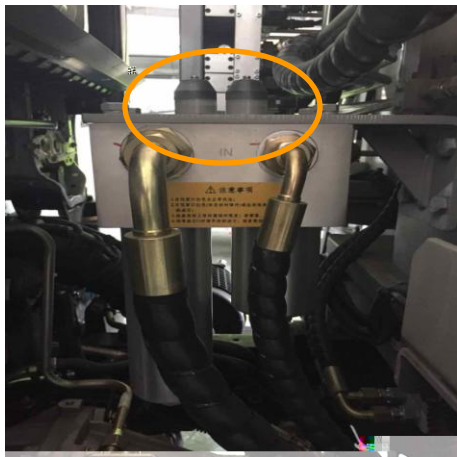
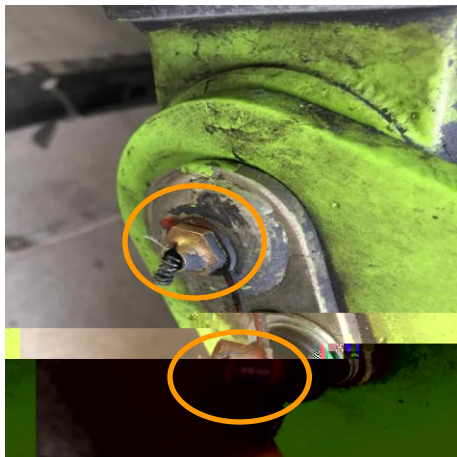

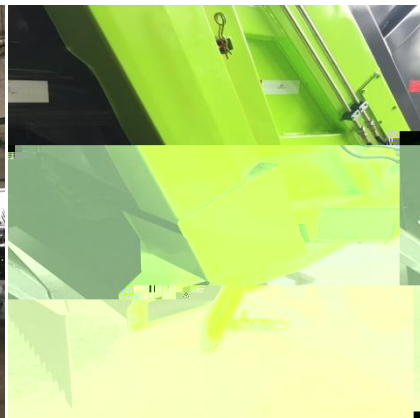
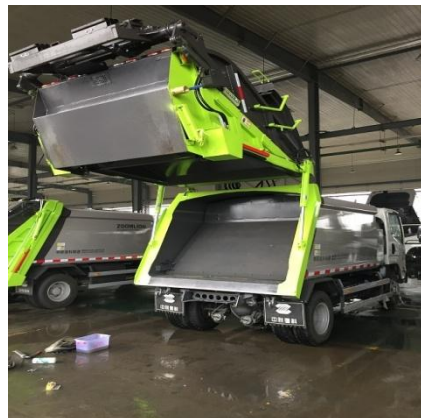

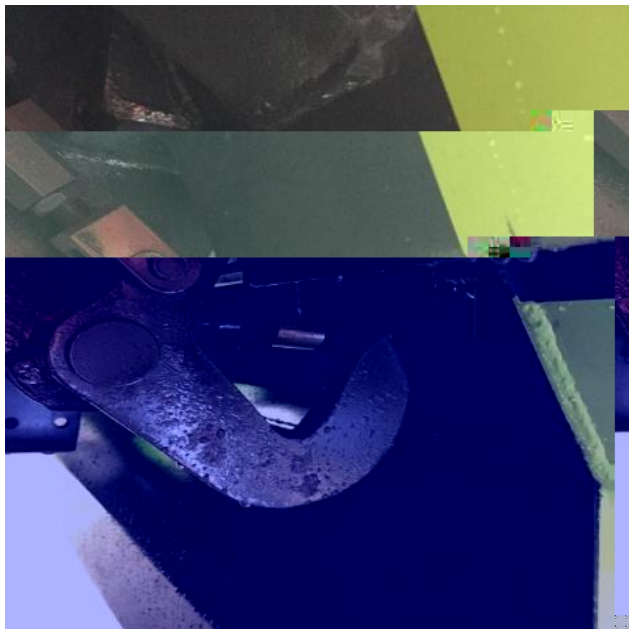

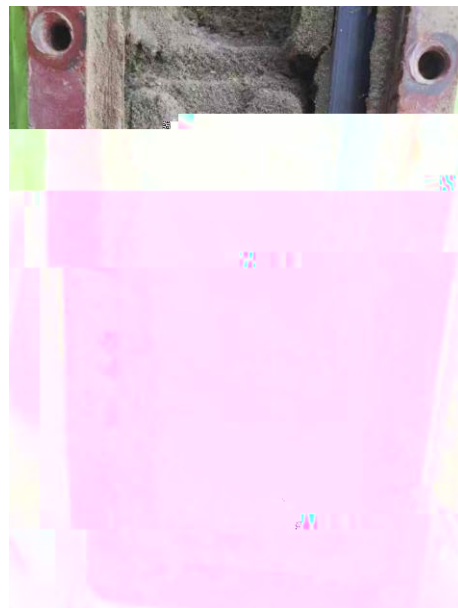

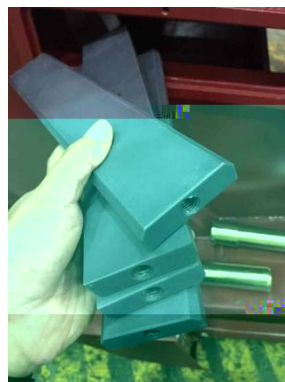
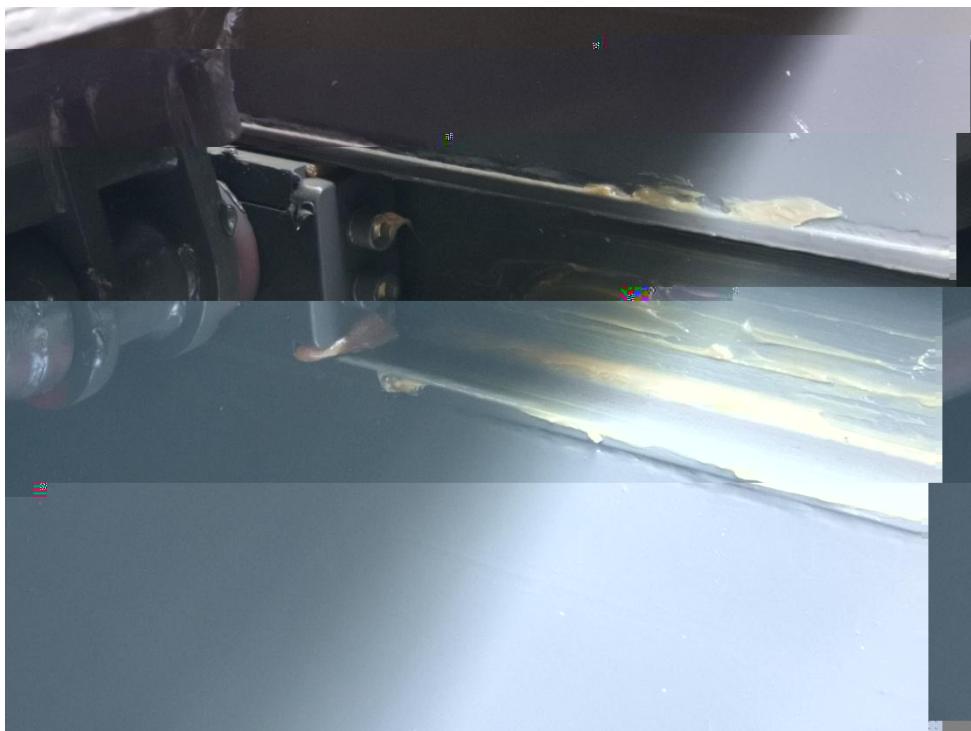

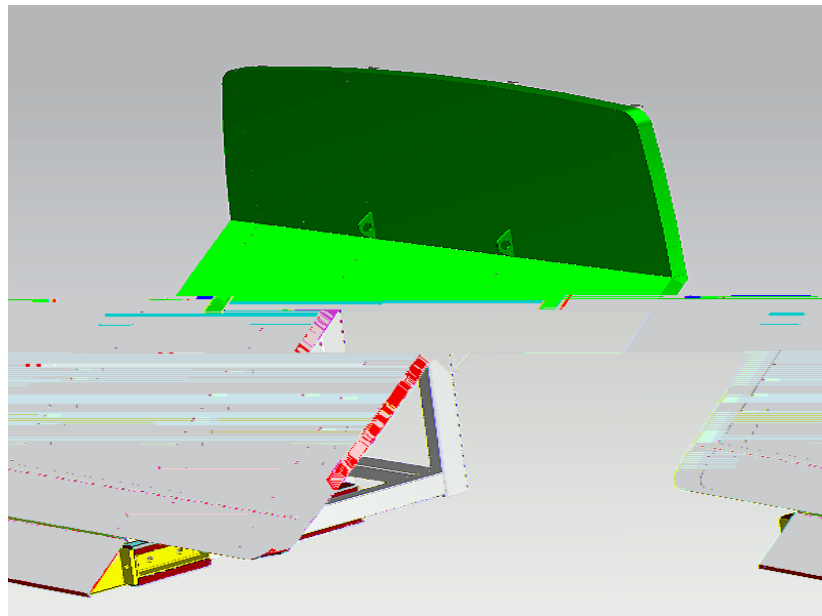
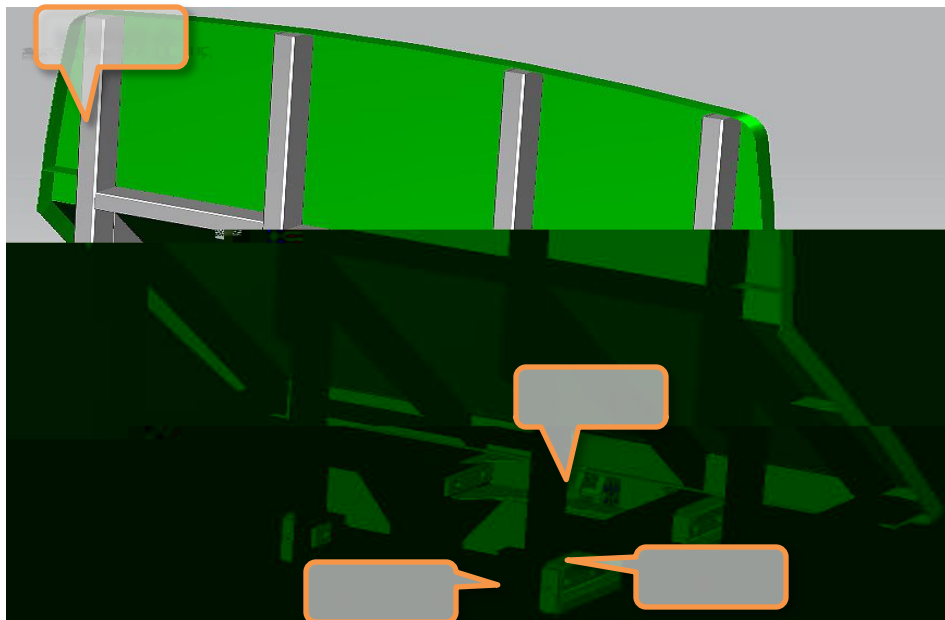

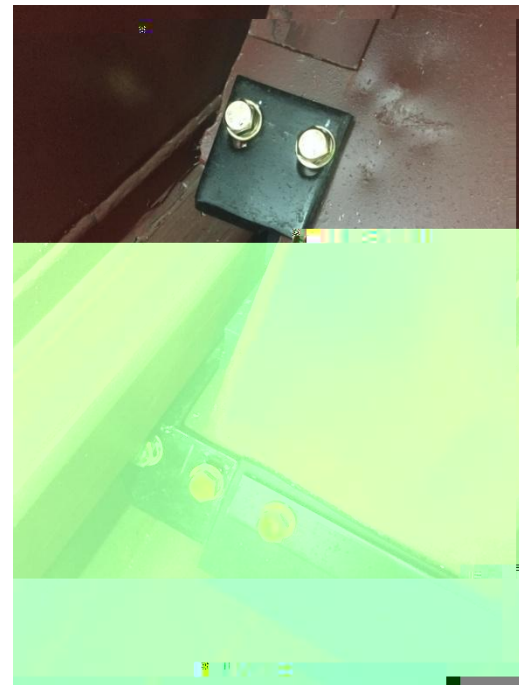
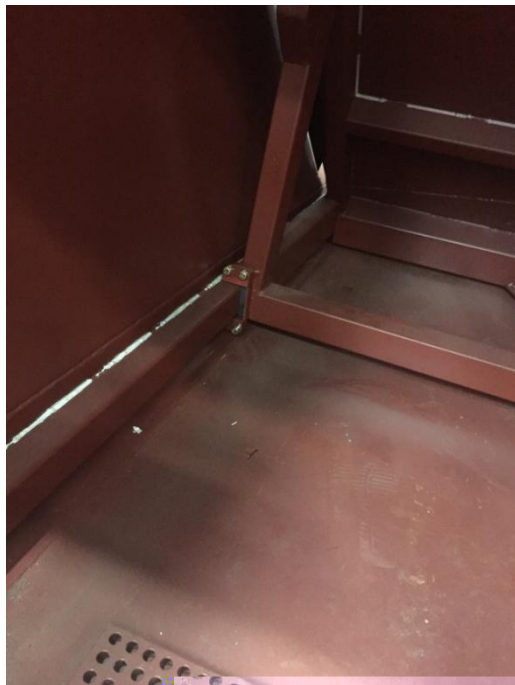

位

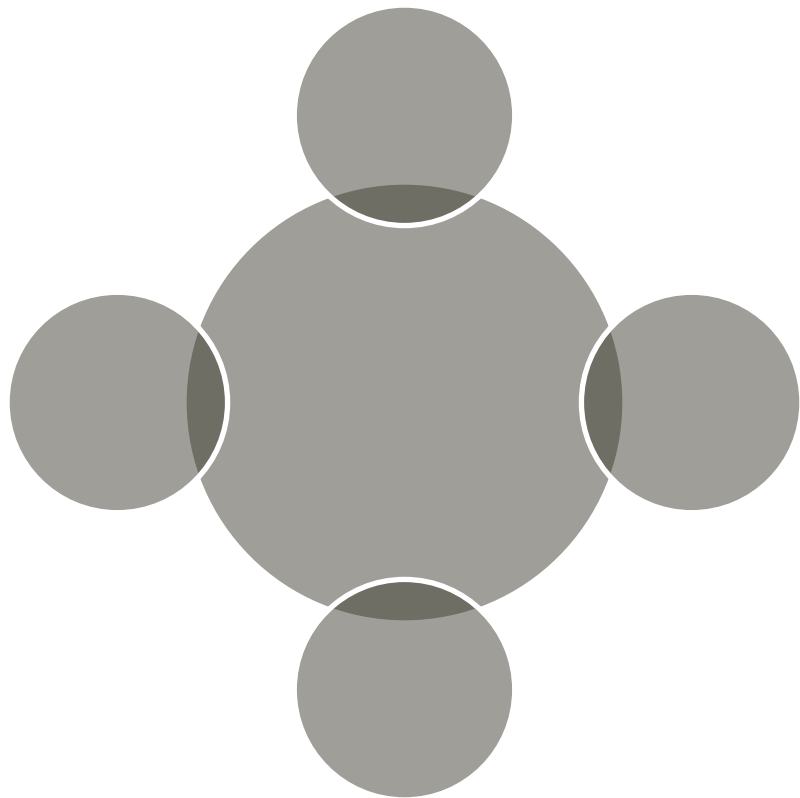

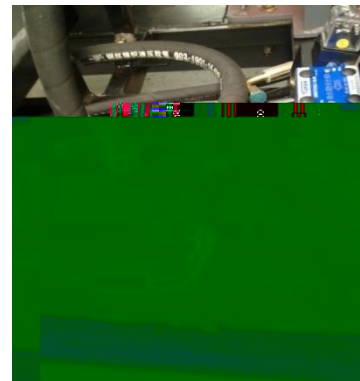
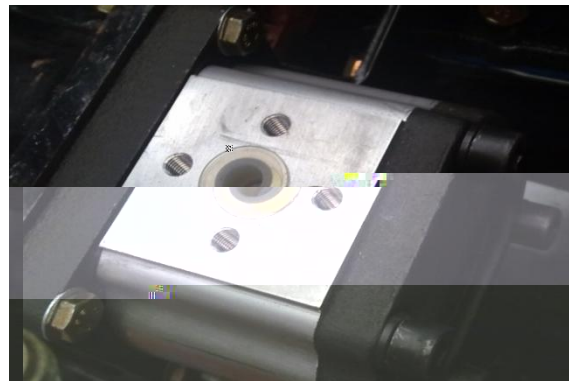



目录 CONTENTS



1

2





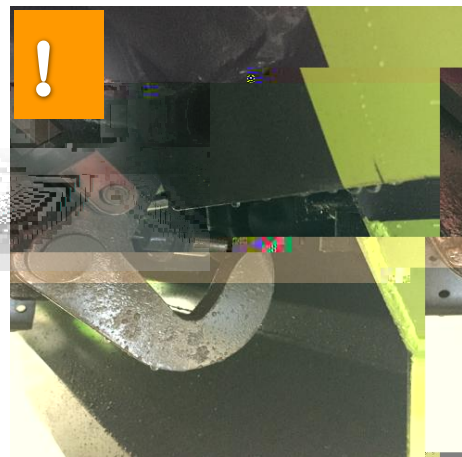
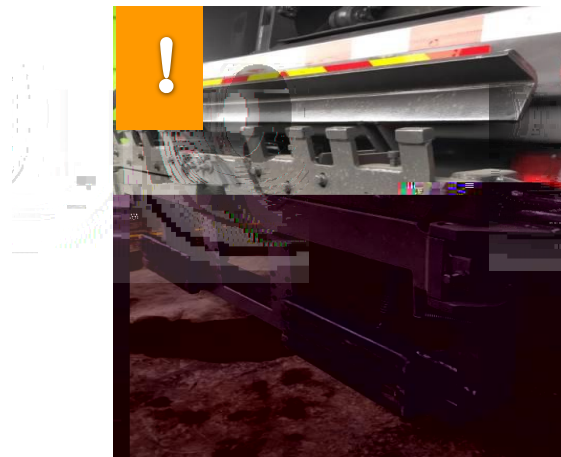
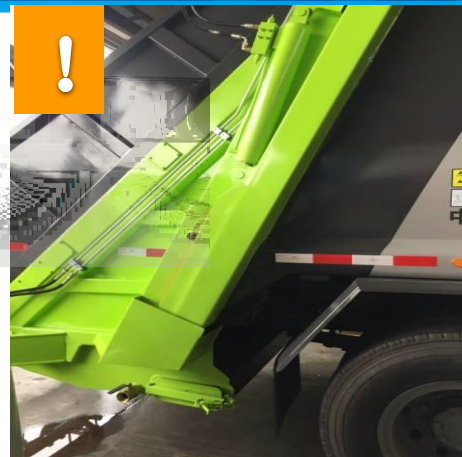
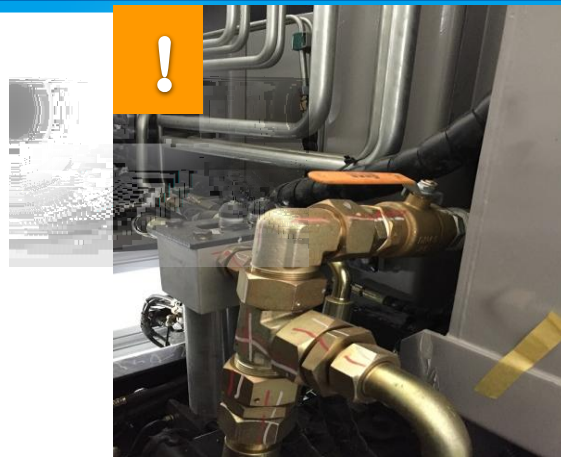

) (

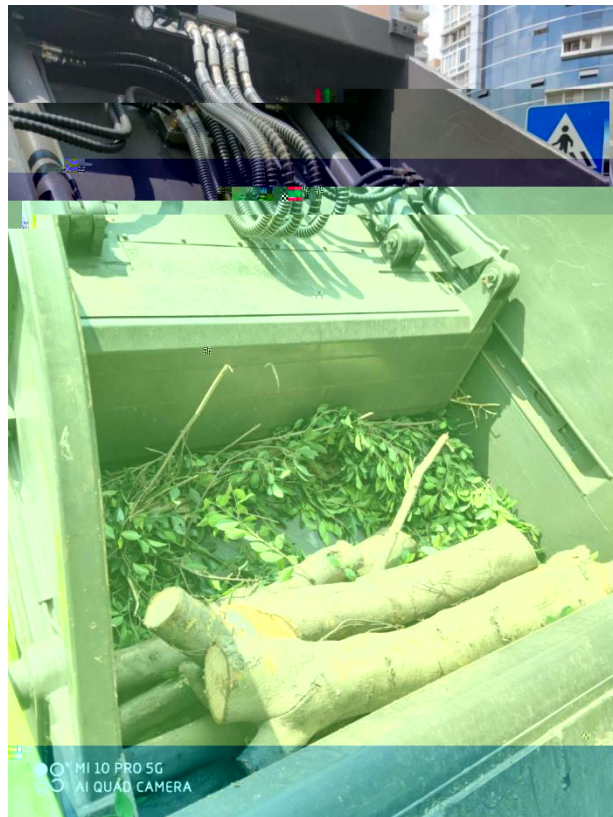

位



3

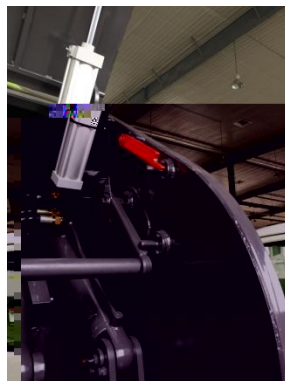

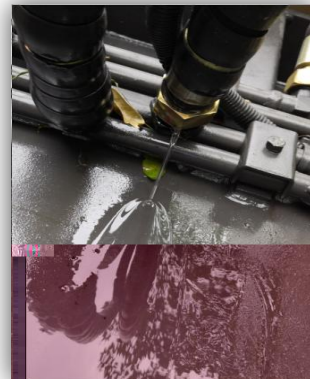
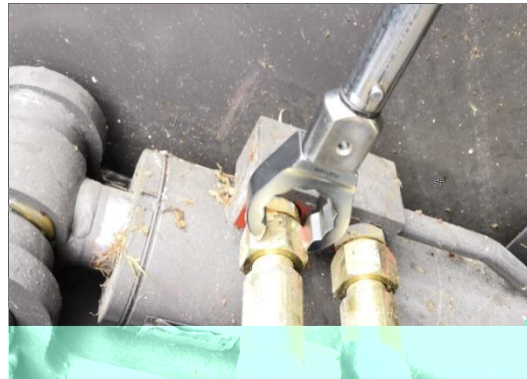
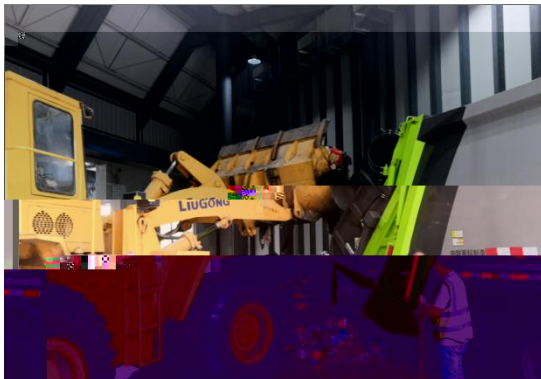

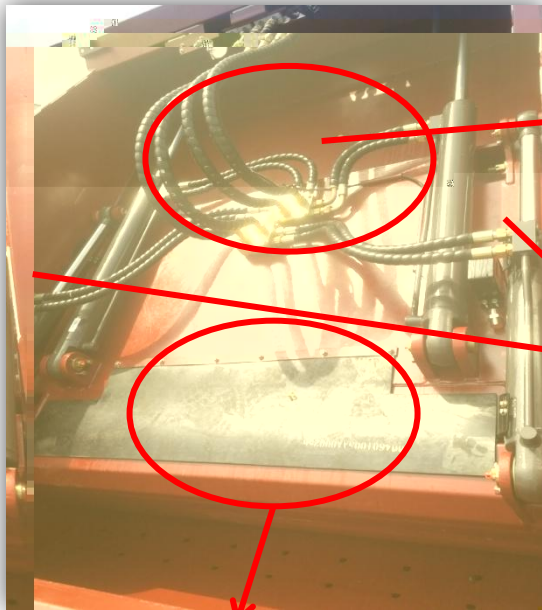

与

+

↑

←

→



盈峰环境科技
INFORE ENVIRONMENT TECHNOLOGY GROUP

2021/6/23

盈峰环境科技集团
INFORE ENVIRONMENT TECHNOLOGY GROUP